

paper wheels

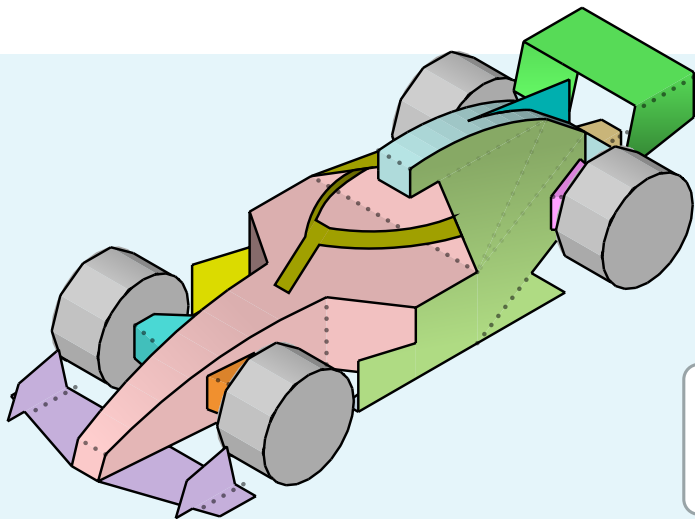

kelwa.co/paperwheels

KELLEN waugh

paper wheels

© 2026 Kellen Waugh. All Rights Reserved.

KELLEN waugh

kelwa.co/paperwheels

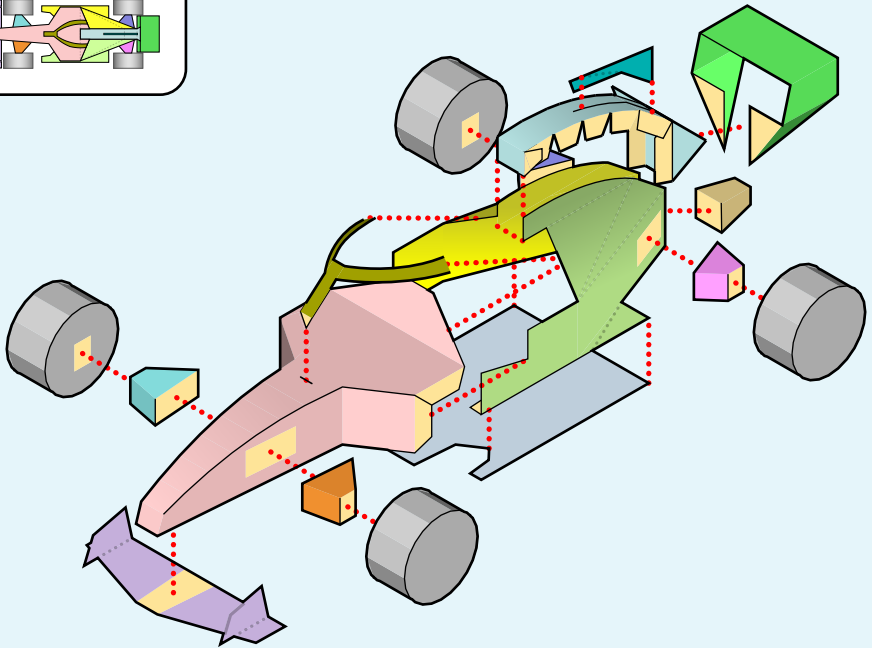
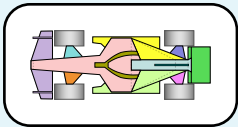

score

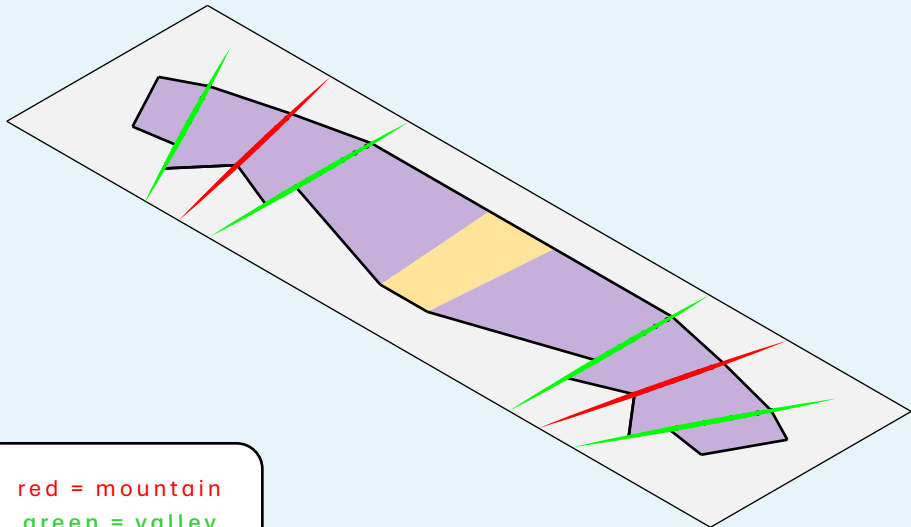
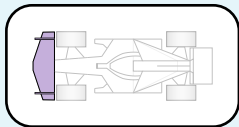

red = mountain

green = valley

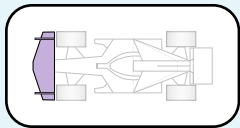

cut out

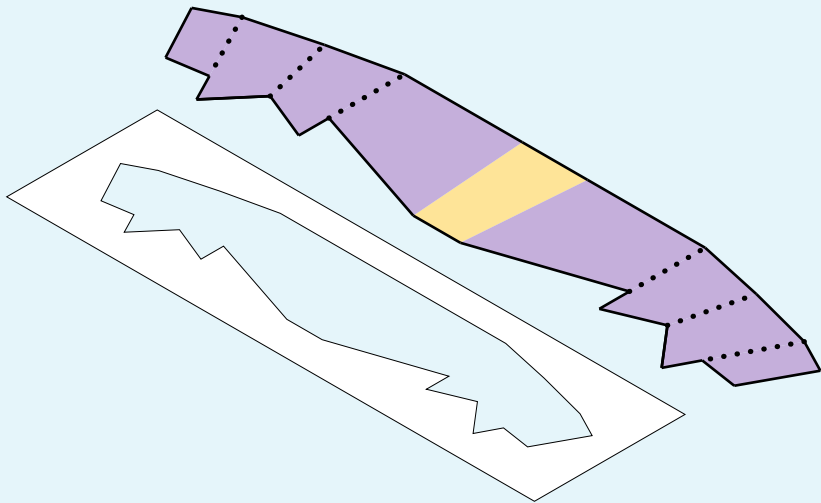

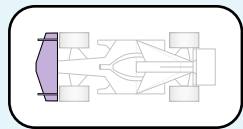

fold

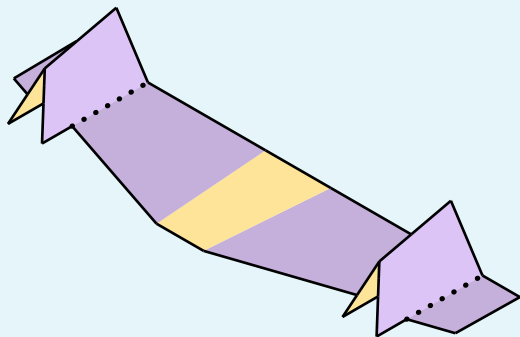

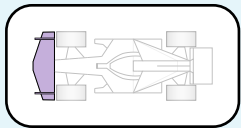

glue

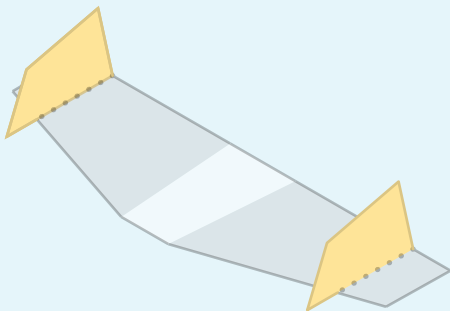

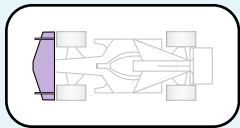

front wing

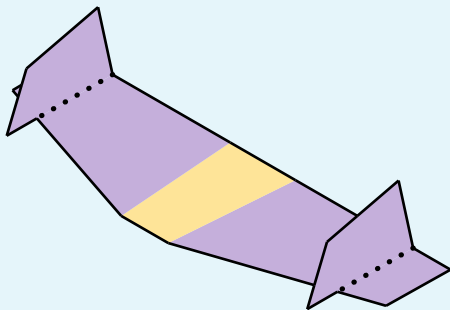

score

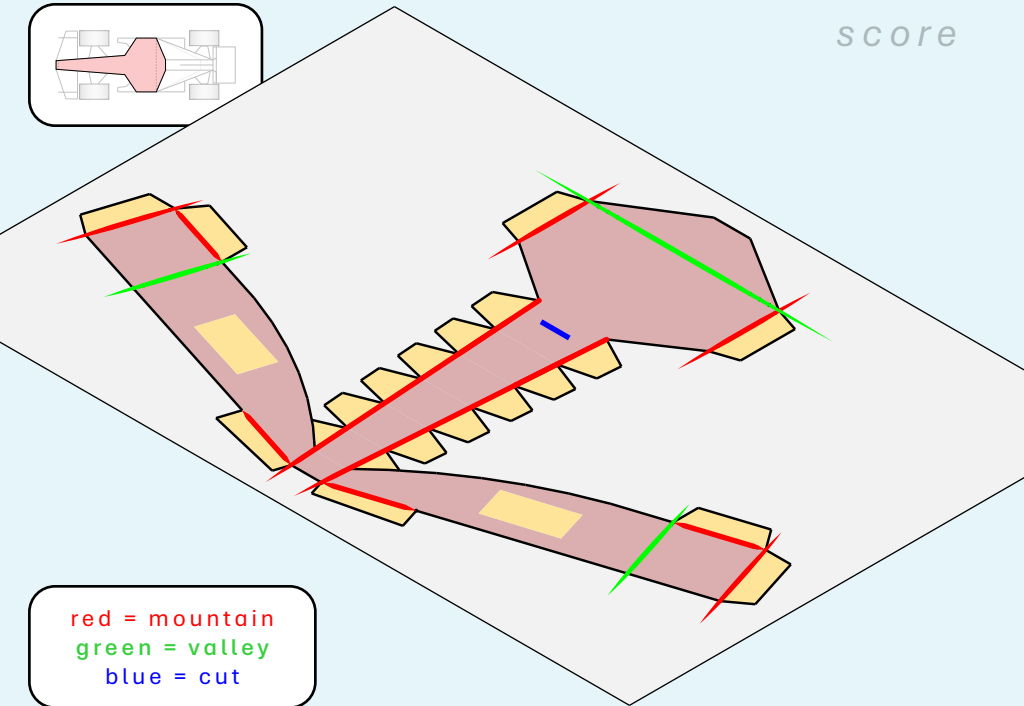
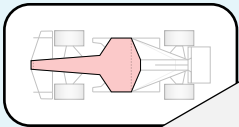

red = mountain
green = valley
blue = cut

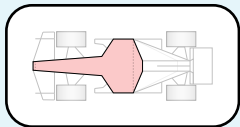

cut out

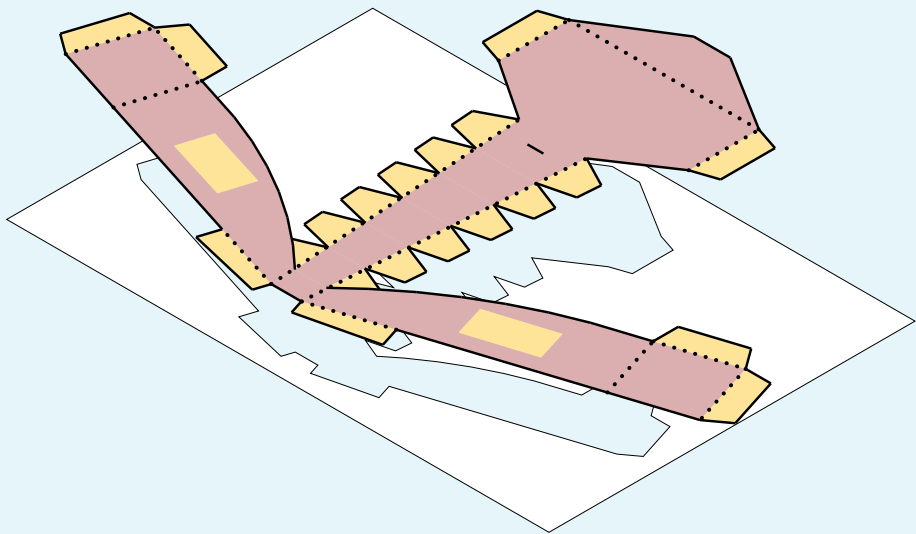

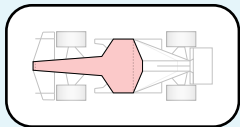

fold tabs

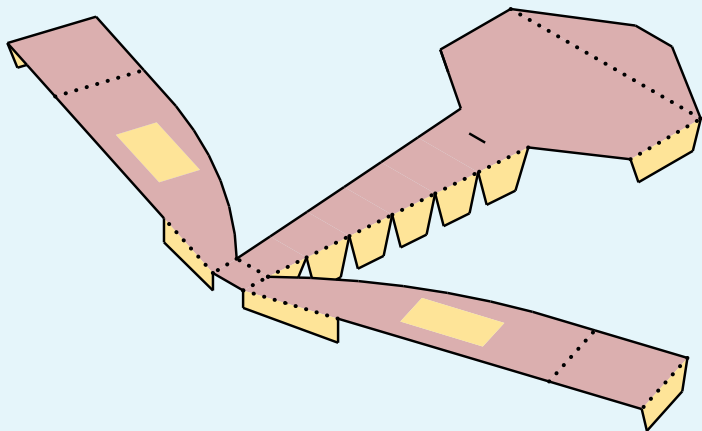

more folding

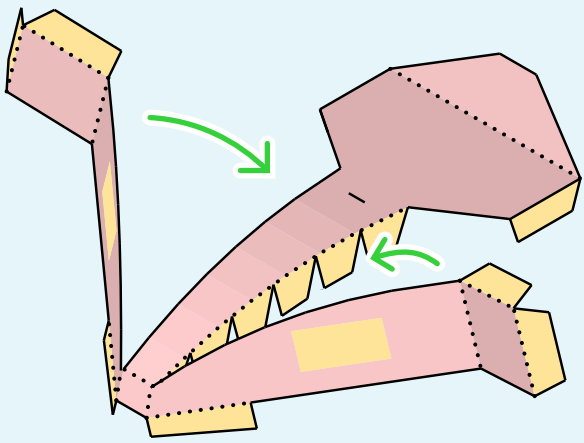
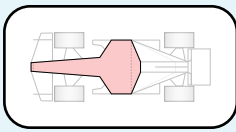

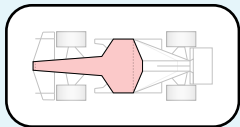

glue

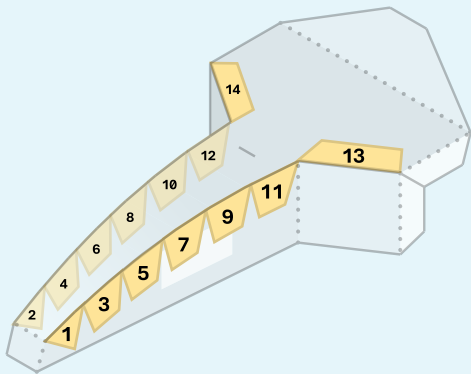

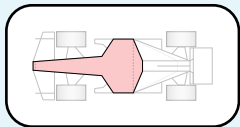

cockpit

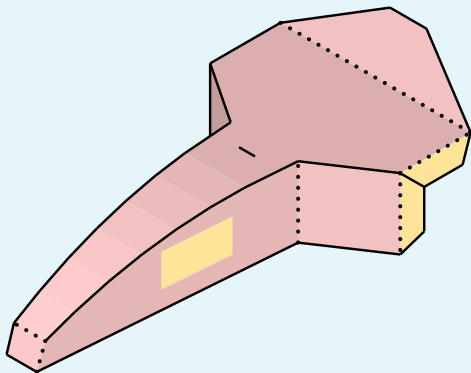

join

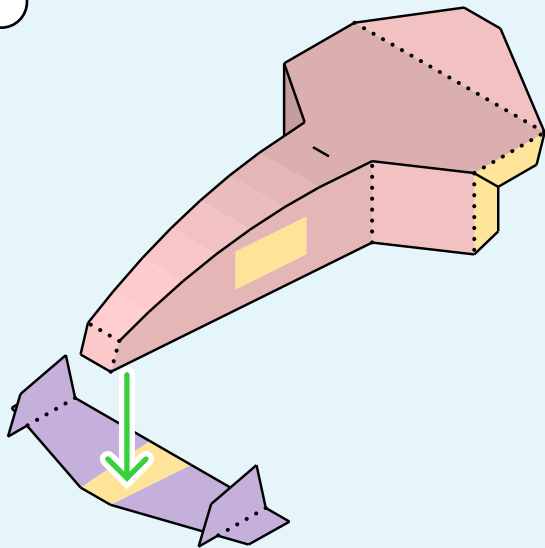
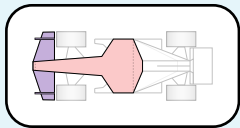

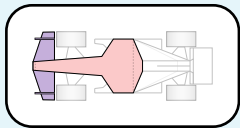

glue

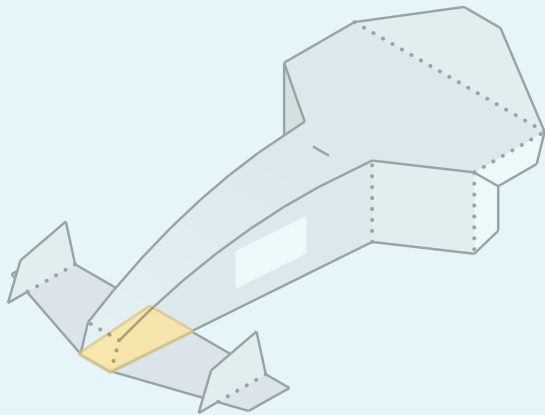

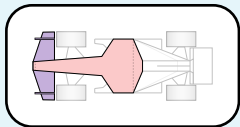

attached

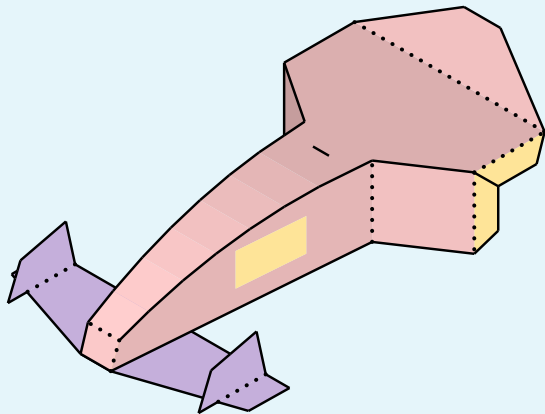

score

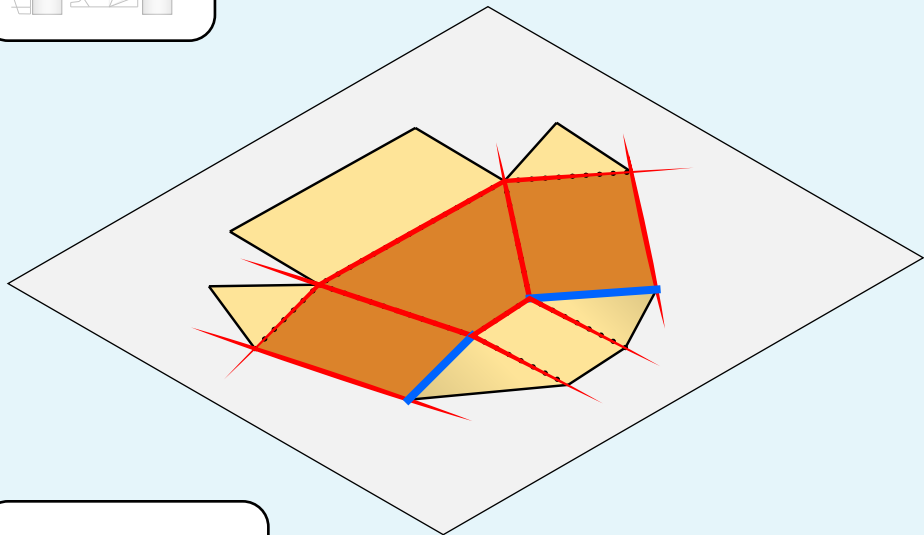
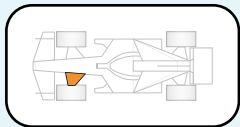

red = mountain

blue = cut

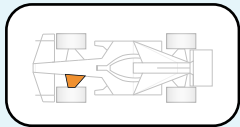

cut out

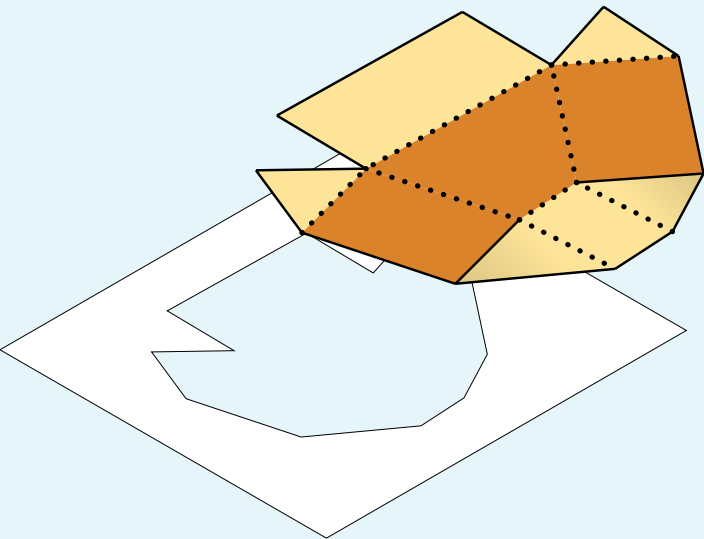

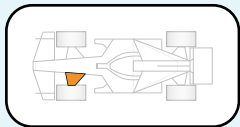

fold

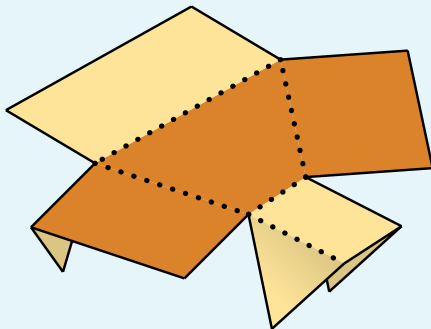

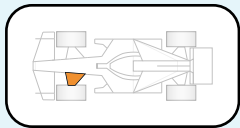

more folding

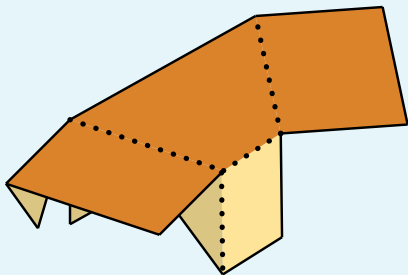

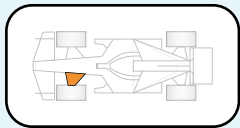

glue

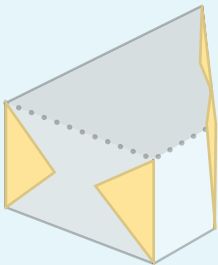

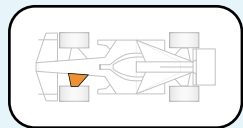

front left axel

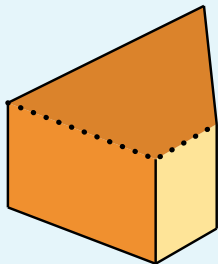

score

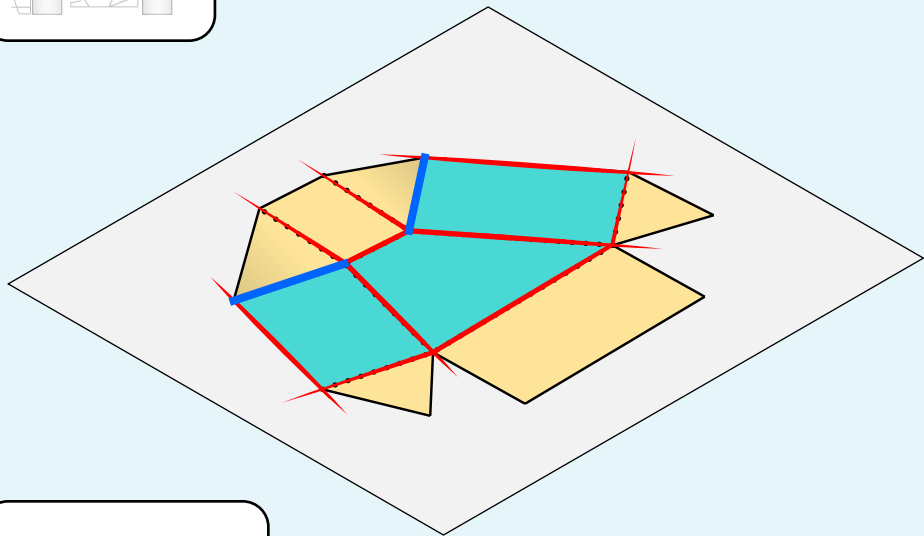
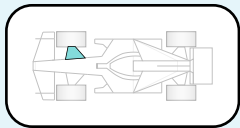

red = mountain

blue = cut

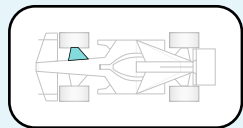

cut out

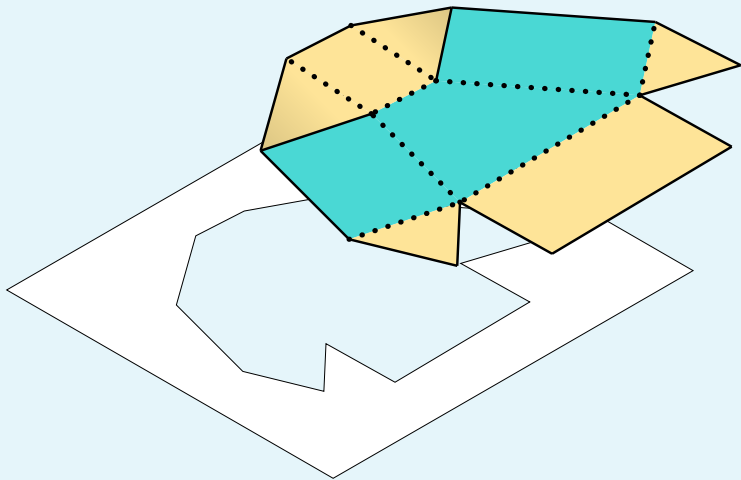

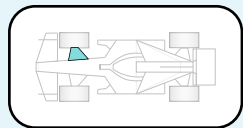

fold

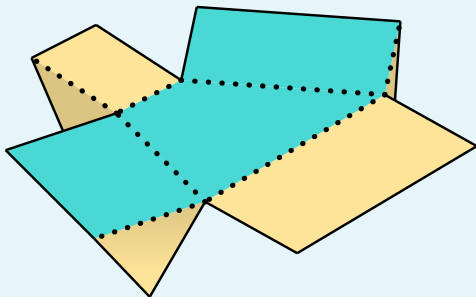

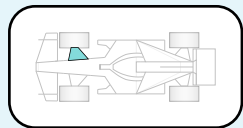

more folding

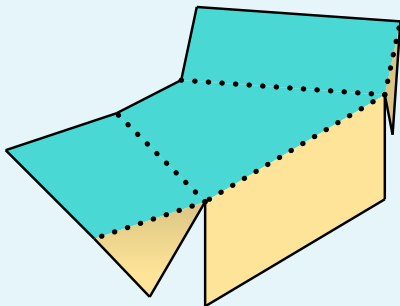

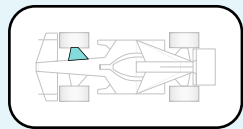

glue

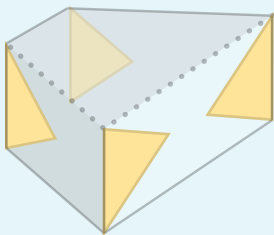

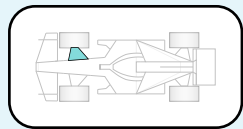

front right axel

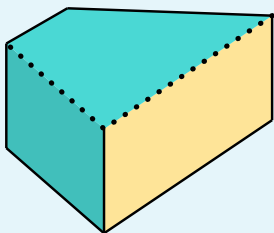

score

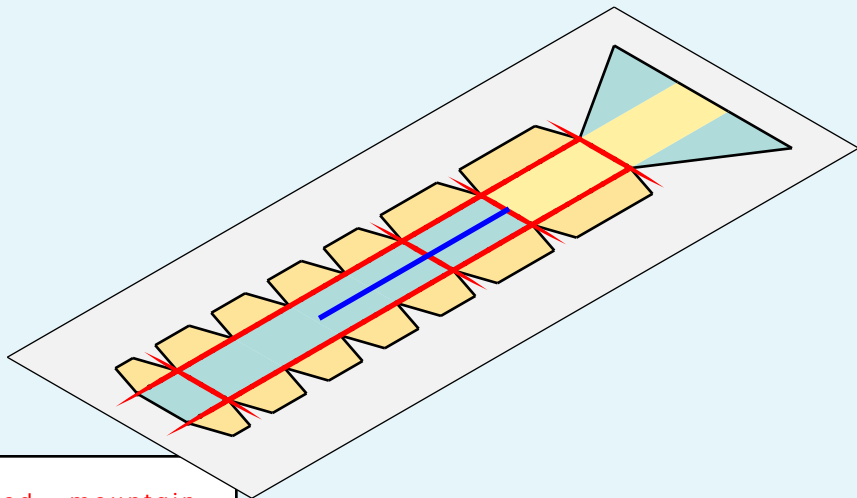
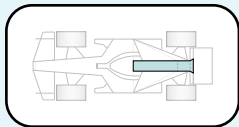

red = mountain

blue = cut

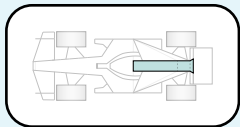

cut out

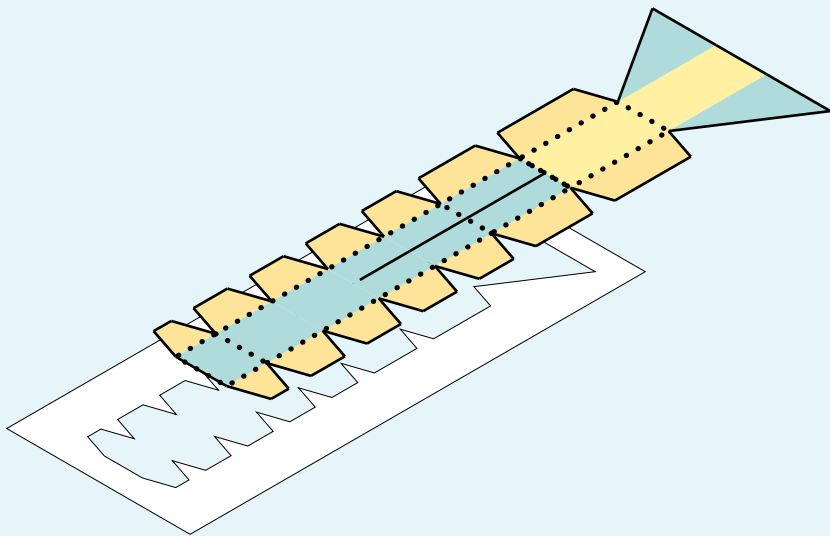

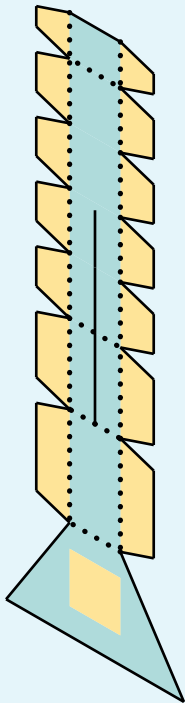
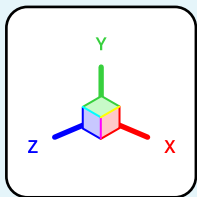
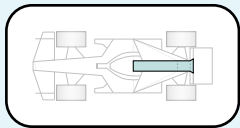

rotate

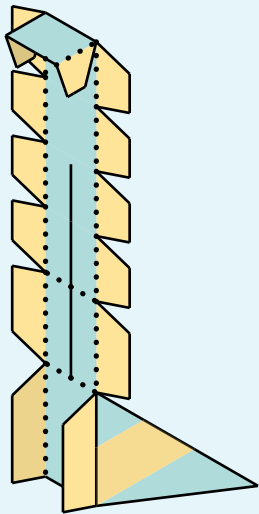
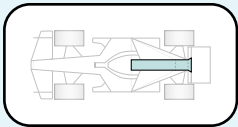

fold

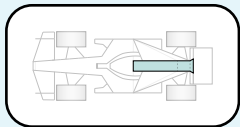

fold tabs

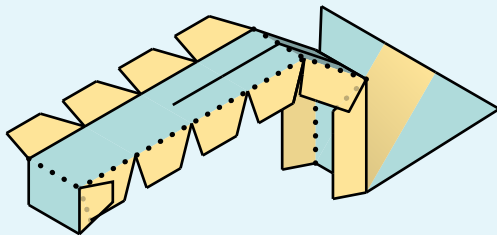

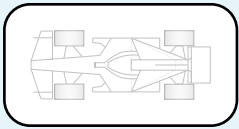

glue

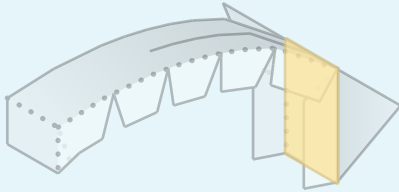

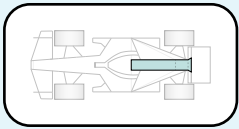

air intake

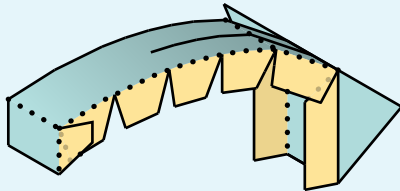

score

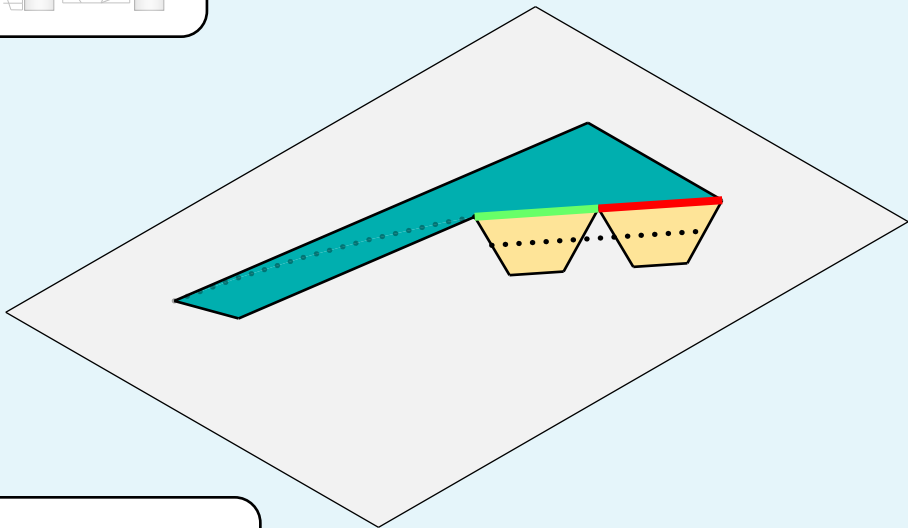
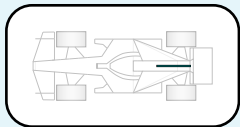

red = mountain

green = valley

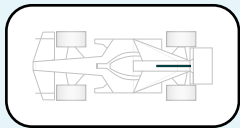

cut out

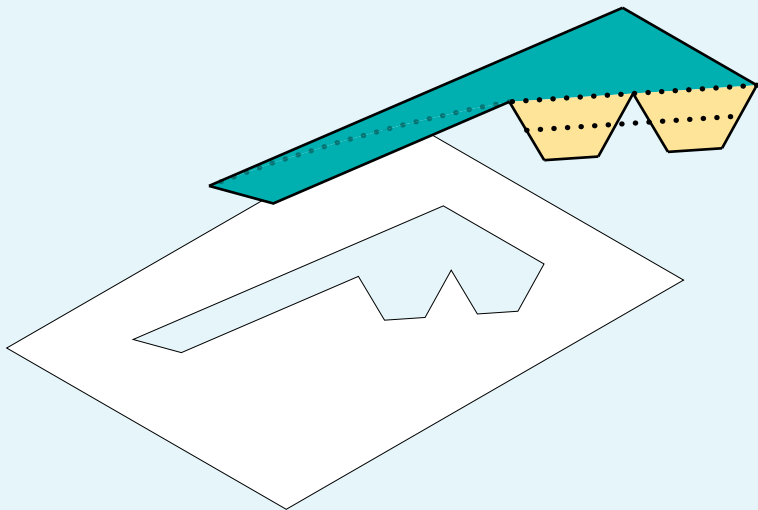

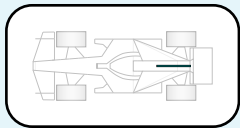

rotate

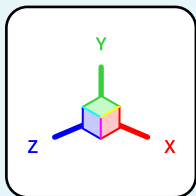
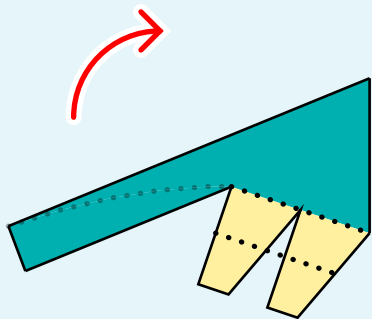

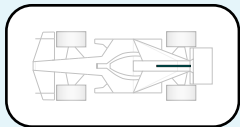

fin

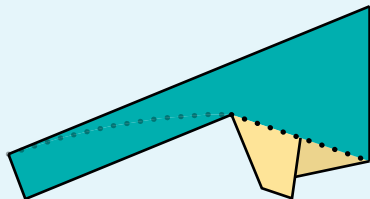

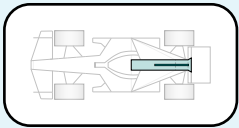

insert

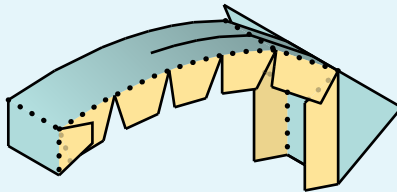
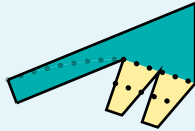

glue

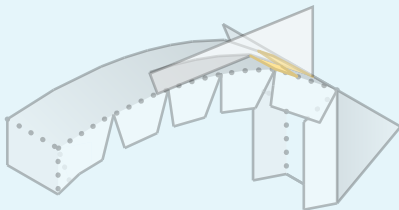
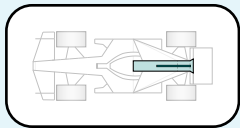

top view

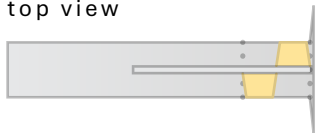

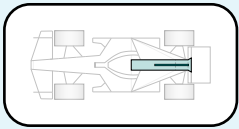

joined

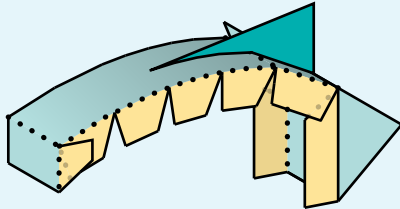

score

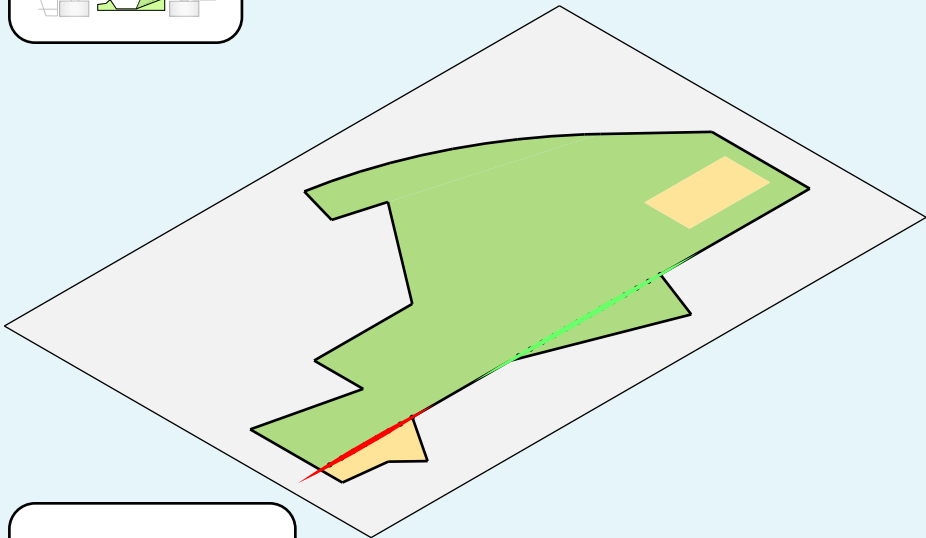
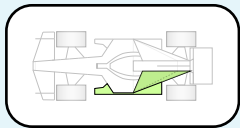

red = mountain
green = valley

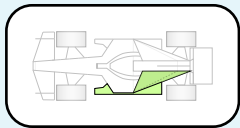

cut out

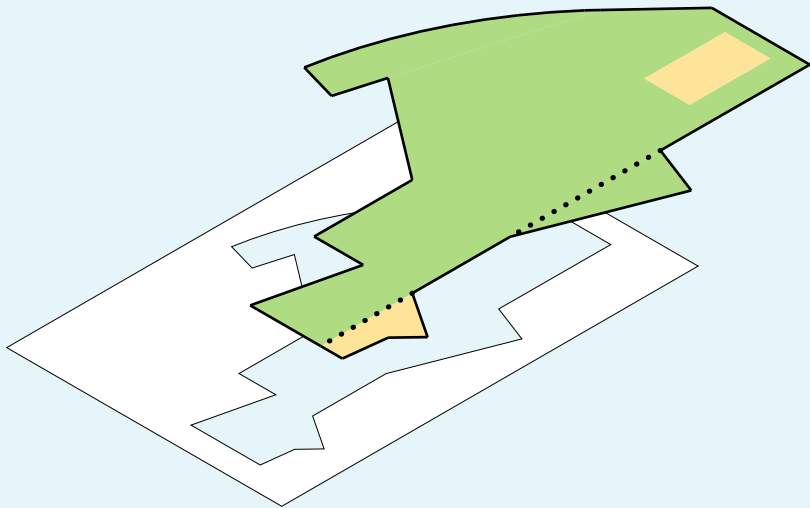

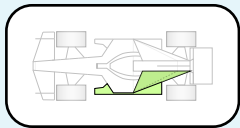

fold

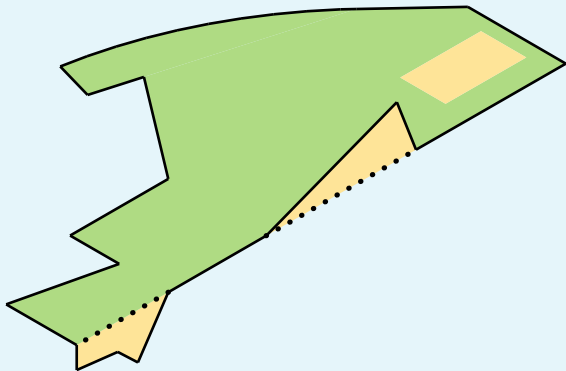

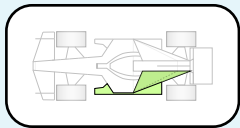

rotate

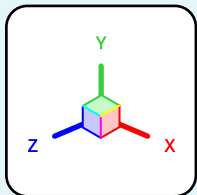
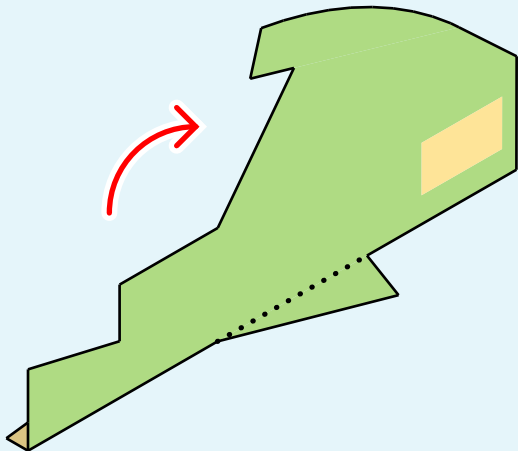

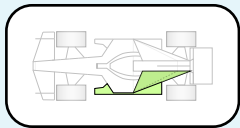

engine (left side)

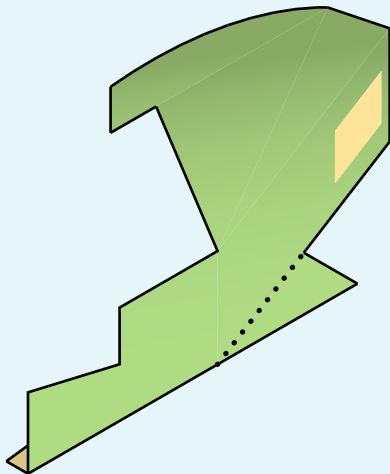

score

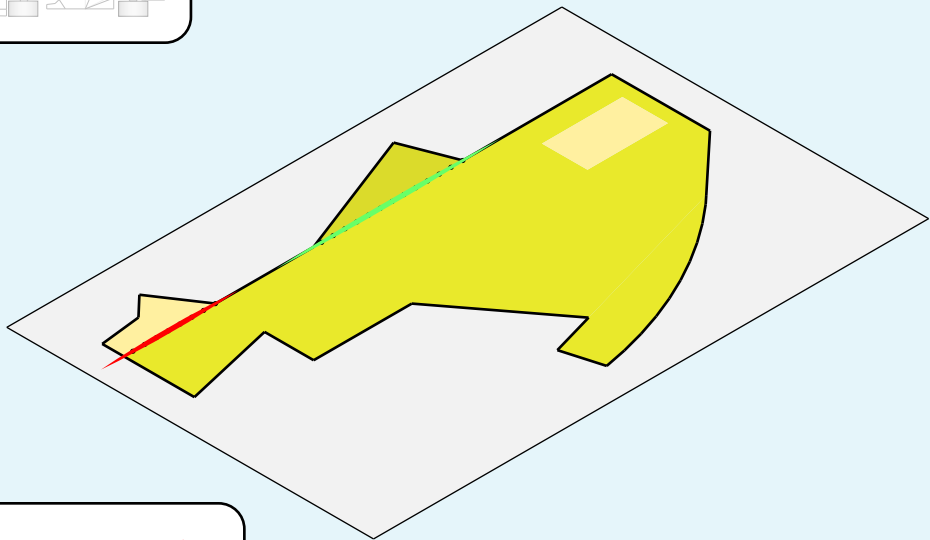
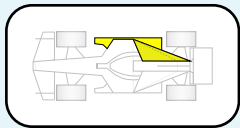

red = mountain

green = valley

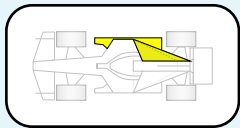

cut out

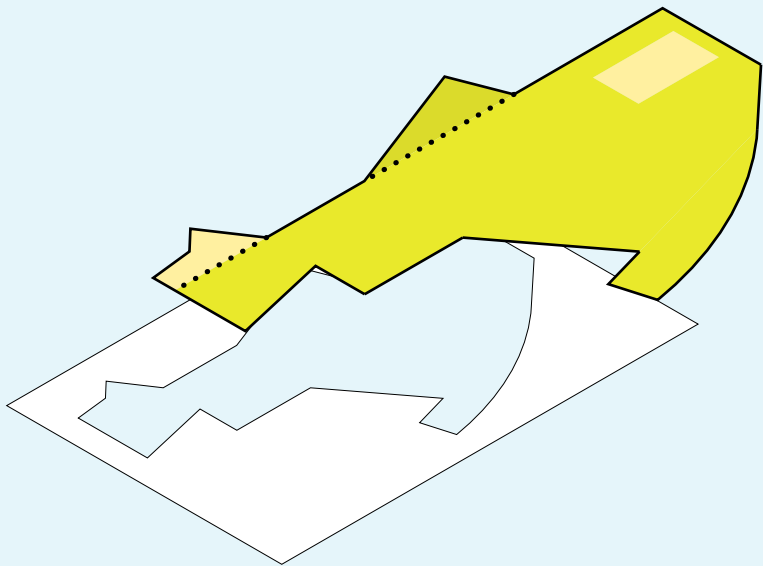

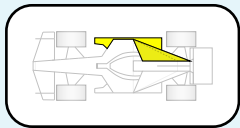

fold

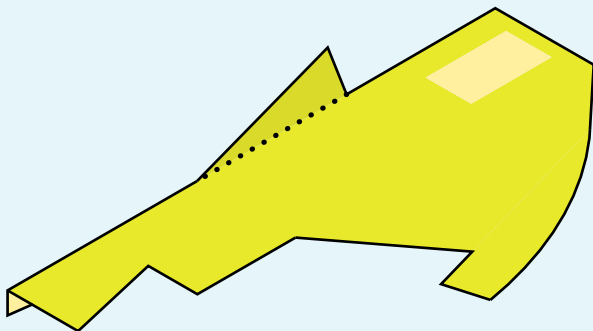

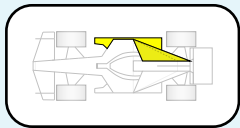

rotate

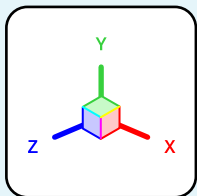
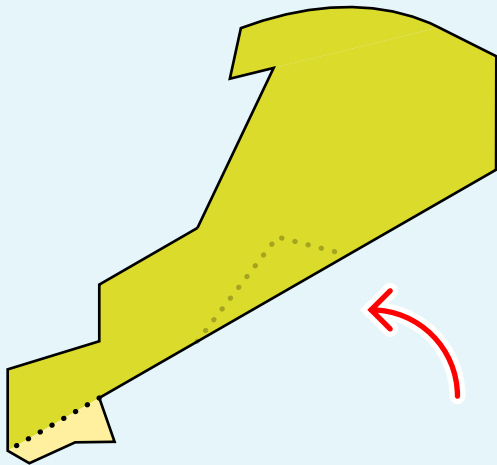

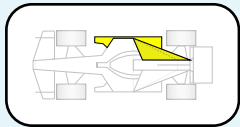

engine (right side)

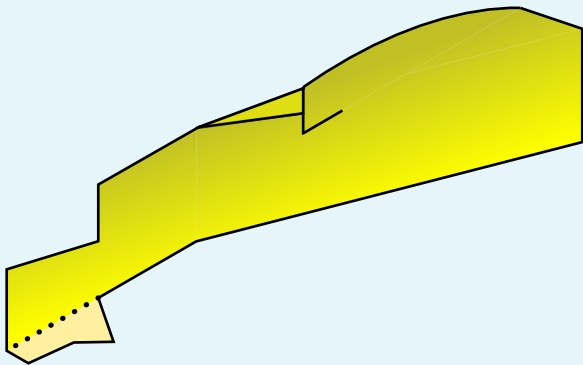

join

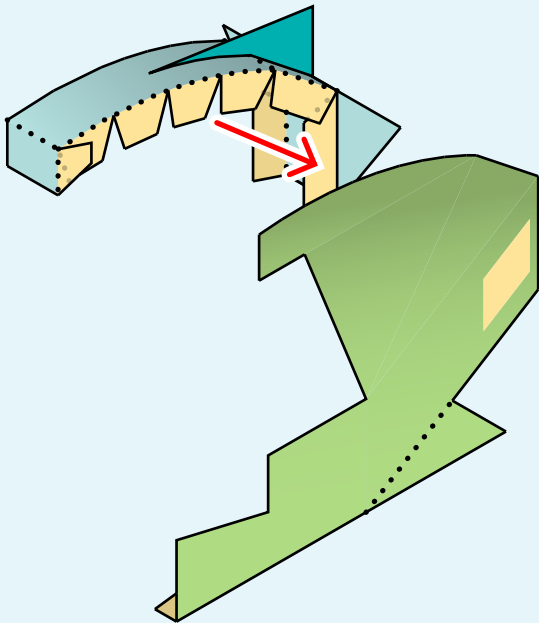
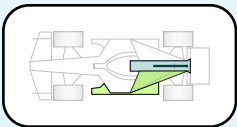

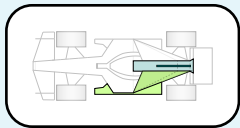

glue

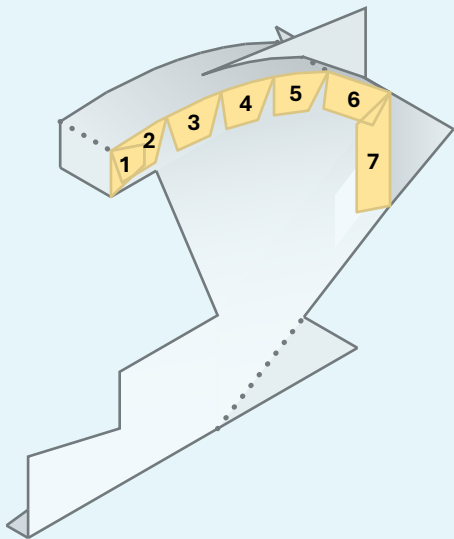

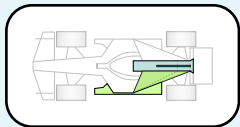

attached

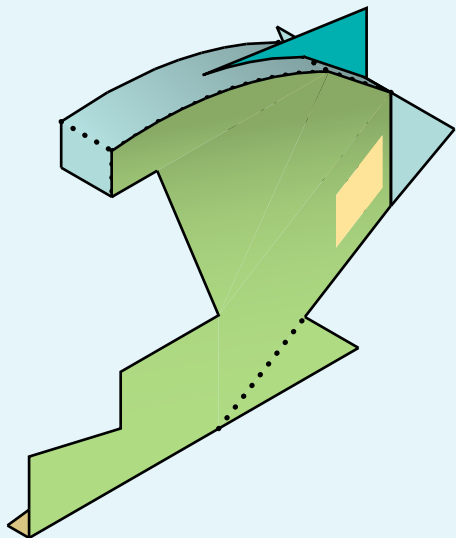

join

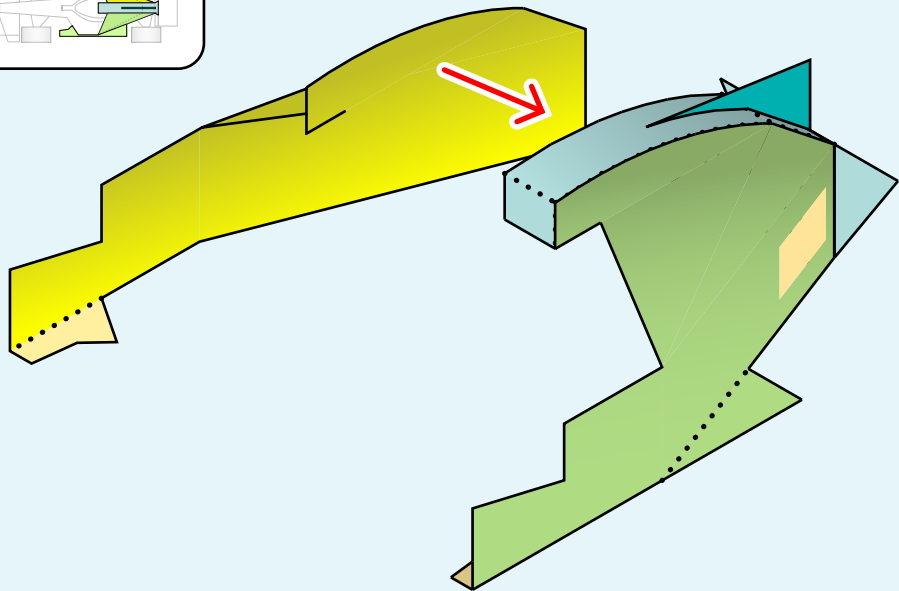
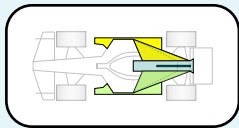

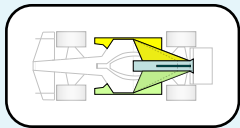

glue

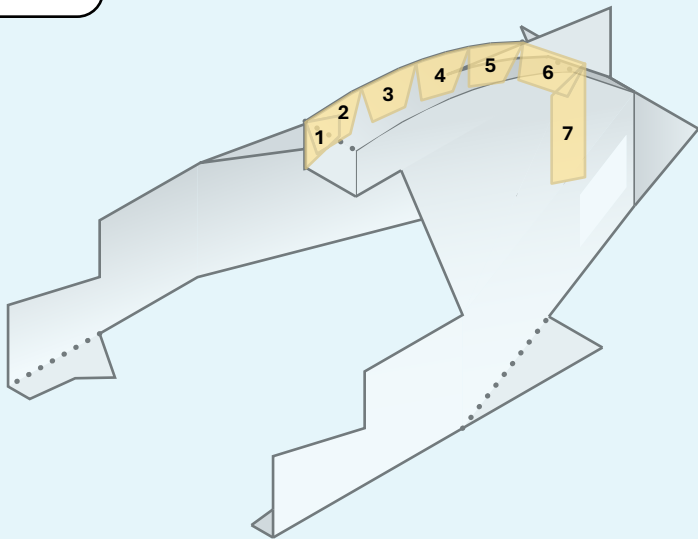

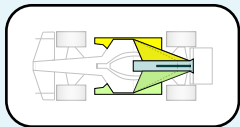

attached

